

EE31

Multifunctional Industrial Transmitter for Humidity / Temperature / Dew Point / Absolute Humidity...

The precise and reliable measurement of humidity in industrial processes is gaining more and more importance. The multifunctional transmitters series EE31 offer the ideal solution.

The result of many years of experience in humidity measurement technology for industrial applications, the EE31 series builds on the E+E high-quality HC series capacitive humidity sensor elements.

The optimal hardware structure for varying applications is achieved by combining various standard mechanical and electronic modules. User friendly MS Windows software tools simplify the configuration of the transmitter, the data recording, visualization and processing.

The measured values are available on two freely configurable and scalable analogue outputs and on the serial RS232 interface. With an optional RS485 module up to 32 transmitters can be connected to a network and one single PC interface allowing easy remote monitoring.

Two freely configurable optional alarm outputs can be set by software. The measured data and the corresponding MIN/MAX values can be viewed on the optional LC display.

Other features especially tailored for harsh industrial applications are the new housing concept consisting of three modules, the easy on-site adjustment and calibration, and the pluggable sensor option. These features allow for very fast and easy servicing of the transmitter.

By selecting a suitable housing version the EE31 series can be used for the entire range of humidity measurement applications:

- Model A for wall mounting
- Model B for duct mounting
- Model D with remote sensing probe for measurements in the extended temperature range -40...180°C (-40...356°F).
- Model E with remote sensing probe for pressure tight applications between 0.01...20 bar (0.15...300psi).



Network with up to 32 transmitters

Up to 32 transmitters can be connected in a RS-485 bus system to a single PC interface.

The measured and calculated data is stored in a PC database which is available for further processing.

The data base can also be stored in ASCII format or in a database with ODBC interface.

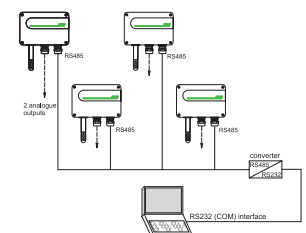

Product Configuration Software (EE-PCS)

The Configuration Software is used for:

- flexible, easy and fast setup of the analogue and alarm outputs.
- adjustment of the humidity and temperature outputs.
- exchange of the sensing probe or of the sensors.

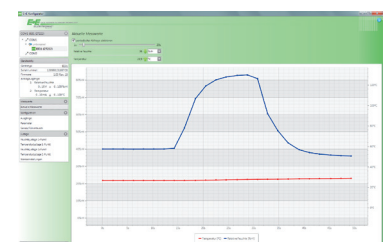

Easy calibration and adjustment of the transmitter

The modular housing of the EE31 enables a fast and easy on-site adjustment and calibration. Using the optional extension cable one can adjust or calibrate the entire measurement loop without interrupting the measurement. No need for time-consuming dismounting and wiring of the instrument.

This feature makes the EE31 series suitable for use in regulatory environments (e.g. FDA, GAMP).

The adjustment of humidity and temperature (2 points or 1 point) is performed either with a simple routine using two push buttons on the printed circuit board or with the configuration software.

2 Status LEDs

Two status LEDs on the printed circuit board indicate the transmitter status and eventual errors, especially useful during installation or service operations.

Sensor Coating

Operation in heavily polluted and/or corrosive environments is typical for many industrial processes and can lead to drift or damage of the humidity sensor and thus to false measured values. The unique protective coating developed by E+E for the sensing probe brings a significant improvement on the long-term stability of the transmitter in very dirty and aggressive environments. (ordering code: HC01)

Integrated Display

The actual measured and calculated values as well as the corresponding Min/Max values can be indicated on an optional display. The physical quantity to be displayed is chosen with the push buttons on the housing. (ordering code: D05)



Pluggable sensing probe

The pluggable sensing probe with plug connection can be easily exchanged in the versions D and E. The installation of the probe cable (up to 20m / 65ft) is significantly simplified and can be installed prior to fitting the transmitter. (ordering code: P01)



Alarm outputs

An optional alarm module with 2 relay outputs is available for control and alarm purposes. The selection of the physical quantity for the relay outputs and the setting of threshold and hysteresis can be easily made with the configuration software included in the standard scope of supply.

Integrated power supply

A power supply, integrated in the back module of the housing, can be ordered optionally (100...240V AC, 50/60Hz; ordering code V01). The power supply V01 is available for both polycarbonate and metal housing and comes standard with two plugs for supply and outputs to allow an easy connection.

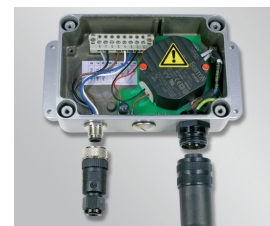

Connection versions

standard

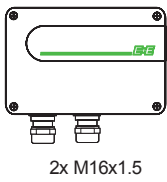

2x M16x1.5

plug option C03

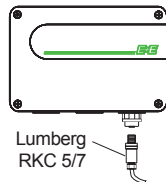

Lumberg RKC 5/7
 power supply+
 analogue output

plug option C06

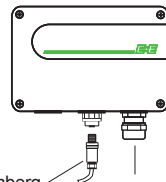

Lumberg RSC 5/7
 M16x1.5
 RS232

plug option C08

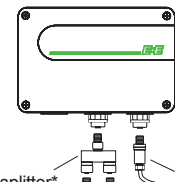

Y splitter*
 Lumberg RSC 5/7
 RS485 network
 Lumberg RKC 5/7
 power supply+
 analogue output

* Siemens 6ES7 194-1KA01-0XA0

Dimensions in mm

Housing:

polycarbonate housing

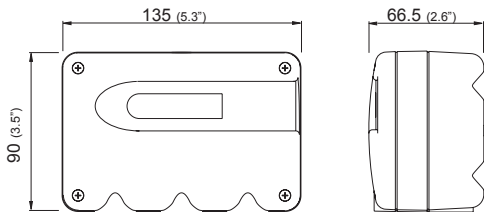

metal housing

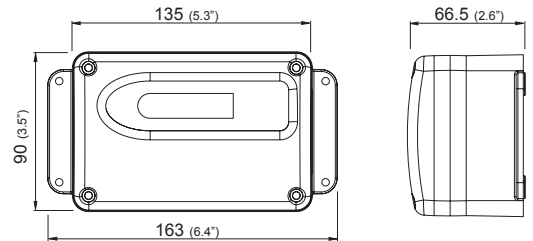

For use in harsh industrial environments all models of the EE31 are available in a robust metal housing. The very smooth surface and the rounded outlines allow for the use in clean rooms as well.

Models:

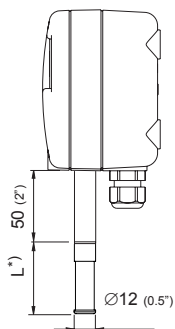

EE31-xAx
Wall mounting
 Probe material: PC

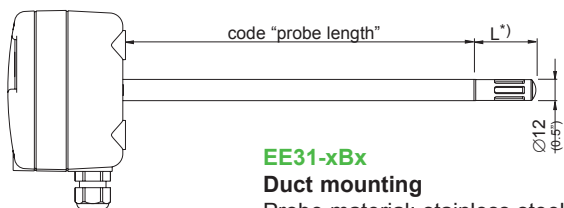

EE31-xBx
Duct mounting
 Probe material: stainless steel

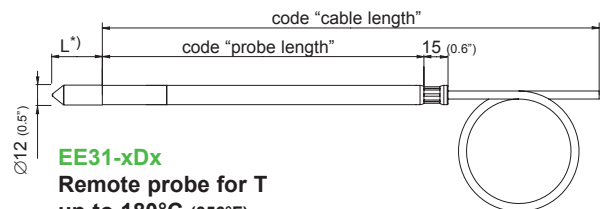

EE31-xDx
Remote probe for T
 up to 180°C (356°F)
 Probe material: stainless steel

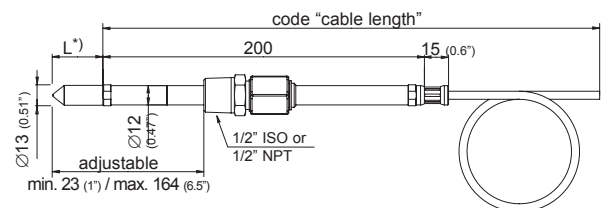

EE31-xEx
Pressure tight probe up to 20bar (300psi)
 Probe material: stainless steel

*) L = Filter length: refer to data sheet "Accessories"

Technical Data

Measurement values

Relative humidity

Humidity sensor ¹⁾	HC1000-400	
Working range ¹⁾	0...100% RH	
Accuracy ¹⁾ (including hysteresis, non-linearity and repeatability, traceable to intern. standards, administrated by NIST, PTB, BEV...)		
-15...40°C (5...104°F) ≤90% RH	± (1.3 + 0.3%*mv) % RH	
-15...40°C (5...104°F) >90% RH	± 2.3% RH	
-25...70°C (-13...158°F)	± (1.4 + 1%*mv) % RH	
-40...180°C (-40...356°F)	± (1.5 + 1.5%*mv) % RH	
Temperature dependence of electronics	typ. ± 0.01% RH/°C (0.0055% RH/°F)	
Response time with metal grid filter at 20°C / t ₉₀	< 15s	

Temperature

Temperature sensor element	Pt1000 (Tolerance class A, DIN EN 60751)	
Working range sensing head	EE31-xAx: -40...60°C (-40...140°F)	EE31-xDx: -40...180°C (-40...356°F)
	EE31-xBx: -40...80°C (-40...176°F)	EE31-xEx: -40...180°C (-40...356°F)

Accuracy

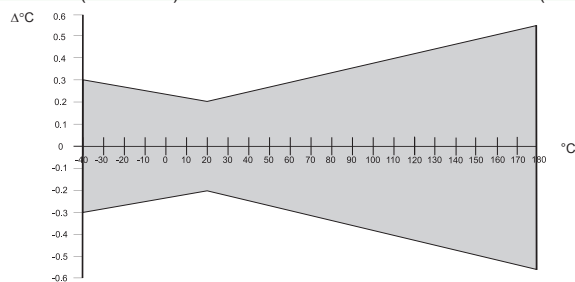

Temperature dependence of electronics	typ. ± 0.005°C/°C
---------------------------------------	-------------------

Outputs²⁾

Two freely selectable and scaleable analogue outputs	0 - 5V	-1mA < I _L < 1mA
0...100% RH / xx...yy°C respectively	0 - 10V	-1mA < I _L < 1mA
	4 - 20mA	R _L < 500 Ohm
	0 - 20mA	R _L < 500 Ohm
Serial interface	RS232C	
	RS485 optional	

Max. adjustable measurement range²⁾³⁾

		from	up to	EE31-A	EE31-B	EE31-D,E	units
Humidity	RH	0	100	100	100	100	% RH
Temperature	T	-40 (-40)	60 (140)	80 (176)	80 (176)	180 (356)	°C (°F)
Dew-point temperature	T _d	-40 (-40)	60 (140)	80 (176)	80 (176)	100 (212)	°C (°F)
Frost-point temperature	T _f	-40 (-40)	0 (32)	0 (32)	0 (32)	0 (32)	°C (°F)
Wet-bulb temperature	T _w	0 (32)	60 (140)	80 (176)	80 (176)	100 (212)	°C (°F)
Water vapour partial pressure	e	0 (0)	200 (3)	500 (7.5)	500 (7.5)	1100 (15)	mbar (psi)
Mixture ratio	r	0 (0)	425 (2900)	999 (9999)	999 (9999)	999 (9999)	g/kg (gr/lb)
Absolute humidity	dv	0 (0)	150 (60)	300 (120)	300 (120)	700 (300)	g/m ³ (gr/F ³)
Specific enthalpy	h	0 (0)	400 (50000)	1000 (375000)	1000 (375000)	2800 (999999)	kJ/kg (Btu/lb)

General

Supply voltage	8...35V DC	
	12...30V AC	(optional 100...240V AC, 50/60Hz)
Current consumption - 2x voltage output	for 24V DC/AC:	typ. 40mA
- 2x current output		typ. 80mA
Pressure range for pressure tight probe	0.01...20bar (0.15...300psi)	
System requirements for software	WINDOWS 2000 or later; serial interface	
Housing / protection class	PC or AI Si 9 Cu 3 / IP65; NEMA 4	
Cable gland	M16 x 1.5 cable Ø 4.5 - 10 mm (0.18 - 0.39")	
Electrical connection	screw terminals up to max. 1.5mm ² (AWG 16)	
Working and storage temperature range of electronics	-40...60°C (-40...140°F)	
	-20...50°C (-4...122°F) - housing with display	
Electromagnetic compatibility according to	EN61326-1	EN61326-2-3 ICES-003 ClassB FCC Part15 ClassB
	Industrial Environment	

1) Refer to the working range of the humidity sensor.

2) Can be easily changed by software.

3) Refer to accuracies of calculated values (www.epluse.com/feuchtemessung).

*) The accuracy statement includes the uncertainty of the factory calibration with an enhancement factor k=2 (2-times standard deviation). The accuracy was calculated in accordance with EA-4/02 and with regard to GUM (Guide to the Expression of Uncertainty in Measurement).

Technical Data for Options

Display	graphical LC display (128x32 pixels), with integrated push-buttons for selecting parameters and MIN/MAX function
Alarm outputs	2 x 1 switch contact 250V AC / 6A 28V DC / 6A
Threshold + hysteresis	can be adjusted with configuration software
Switching parameters	freely selectable between: RH Relative humidity T Temperature Td Dew-point temperature Tf Frost-point temperature Tw Wet-bulb temperature e Water vapour partial pressure r Mixture ratio dv Absolute humidity h Specific enthalpy

Working range humidity sensor

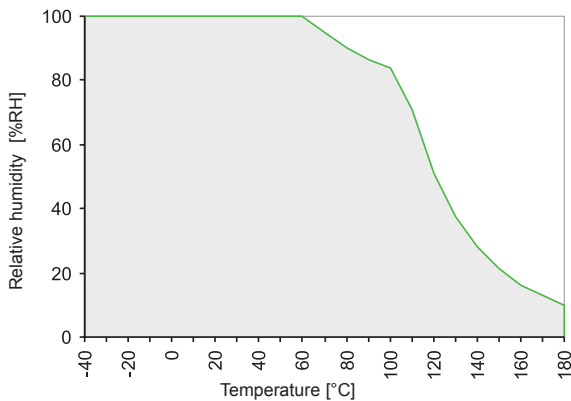

The grey area shows the allowed measurement range for the humidity sensor.

Operating points outside of this range do not lead to destruction of the element, but the specified measurement accuracy cannot be guaranteed.

Connection diagram

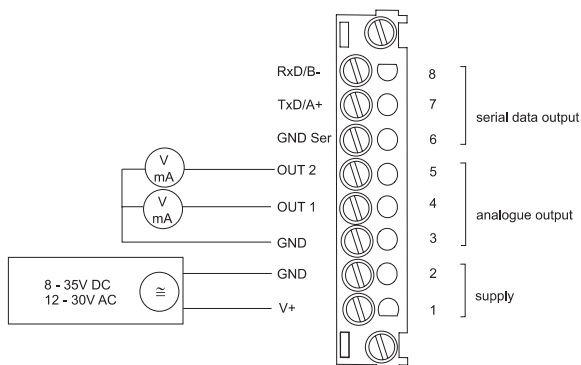

Terminal configuration - Alarm output

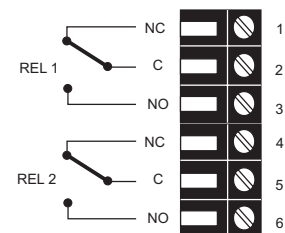

Scope of Supply

	Included in all versions	According to ordering guide
EE31 according to ordering guide	✓	
Manual EE31 German/English/French	✓	
Inspection certificate according to DIN EN 10204 – 3.1	✓	
Allen key 3.0		
Mating plug for integrated power supply		only for metal housing V01
Mating plug RKC 5/7		V01 / C03 / C08
Y-junction for network connection		C08 & N
Mating plug RSC 5/7		C06 / C08
M16 Cable gland metal		except C03, C06, C08, V01

Ordering Guide

		EE31-	EE31-	EE31-	EE31-
Hardware Configuration					
Housing	metal housing	M	M	M	M
	polycarbonate housing	P	P	P	P
Type	humidity + temperature	FT	FT	FT	FT
Model		A	B	D	E
Filter	stainless steel sintered filter	3	3	3	3
	PTFE filter	5	5	5	5
	H ₂ O ₂ filter	8	8	8	8
	stainless steel grid filter (up to 180°C/ 356°F)	9	9	9	9
Cable length (incl. probe length)	2m (6.6ft)			02	02
	5m (16.4ft)			05	05
	10m (32.8ft)			10	10
	20m (65.6ft)			20	20
Probe length	65mm (2.6")			2	
	200mm (7.9")		5	5	5
	400mm (15.8")		6	6	
Pressure tight feedthrough	1/2" male thread				HA03
	1/2" NPT thread				HA07
Interface	RS232				
	RS485	N	N	N	N
Display	without display				
	with display	D05	D05	D05	D05
Alarm output¹⁾	without relay				
	with relay	SW	SW	SW	SW
Plug	cable glands				
	1 plug for power supply and outputs	C03	C03	C03	C03
	1 cable gland / 1 plug for RS232	C06	C06	C06	C06
	2 plugs for power supply/outputs and RS485 Network	C08	C08	C08	C08
Sensing probe	fixed				
	pluggable			P01	P01
Coating sensor	no				
	yes	HC01	HC01	HC01	HC01
Supply voltage	8...35V DC / 12...30V AC				
	integrated power supply 100...240V Ac, 50/60Hz ²⁾	V01		V01	V01
Software Configuration					
Physical parameters of outputs	relative humidity	RH [%]	(A)	Output 1	Select according to Ordering Guide(A-H, J)
	Temperature	T [°C]	(B)		
	Dew point temperature	Td [°C]	(C)	Output 2	Select according to Ordering Guide(A-H, J)
	Frost point temperature	Tf [°C]	(D)		
	wet bulb temperature	Tw [°C]	(E)		
	water vapour partial pressure	e [mbar]	(F)		
	mixture ratio	r [g/kg]	(G)		
	absolute humidity	dv [g/m ³]	(H)		
	specific enthalpy	h [kJ/kg]	(J)		
	Type of output signals	0-5V		(2)	
0-10V			(3)		
0-20mA			(5)		
4-20mA			(6)		
Measured value units	metric / SI				
	non metric / US			E01	E01
Scaling of T-output	-40...60 (T02)	-20...80 (T24)	0...350 (T89)	Output T	Select according to Ordering Guide (Txx)
Scaling of Td-output in °C or °F	0...50 (T04)	0...180 (T26)	32...120 (T90)		
	0...100 (T05)	-40...180 (T52)	32...140 (T91)	Output Td	Select according to Ordering Guide (Tdx)
	0...60 (T07)	-40...100 (T79)	32...180 (T92)		
	-40...120 (T12)	-40...350 (T82)	32...250 (T94)		
	0...120 (T16)	-40...140 (T83)	32...300 (T95)		
	0...80 (T21)	-40...300 (T84)	32...132 (T96)		
	-40...80 (T22)	0...250 (T88)	32...350 (T101)		
					Other T and Td-scaling refer to datasheet T-Scaling

1) Combination alarm output and plugs is not possible (with cable glands only) / combination alarm output and integrated power supply is not possible
 2) Integrated power supply includes 2 plugs for power supply and outputs / further plug options are not possible

Order Example

EE31-PFTB55SW/BC2-T07-Td03

Housing:	polycarbonate housing	Output 1:	T
Type:	humidity + temperature	Output 2:	Td
Model:	duct mounting	Output signal:	0-5V
Filter:	PTFE Filter	Scaling of T-output:	0...60°C
Probe length:	200mm (7.9")	Scaling of Td-output:	-10...50°C
Alarm output:	with relay		

Accessories / Replacement Parts (For further information, see data sheet "Accessories")

- Filter caps	(HA0101xx)	- Interface cable for plugs C06	(HA010311)
- Display + housing cover in metal	(D05M)	- Bracket for installation onto mounting rails*	(HA010203)
- Display + housing cover in polycarbonate	(D05P)	- Drip water protection	(HA010503)
- Sensing probe	(Pxx)	- Calibration set	(HA0104xx)
- Humidity sensor	(FE09 or FE09-HC01)	- Mounting flange stainless steel	(HA010201)
- Interface cable for PCB	(HA010304)		

* Note: Only for plastic housing, not for metal housing