

USER'S GUIDE

EE650 - Air Velocity Transmitter for HVAC Applications

GENERAL

The EE650 transmitter is designed for accurate measurement of air velocity in HVAC. It operates on the hot-film anemometer principle and features the innovative, very robust E+E VTQ sensing element manufactured in thin-film technology combined with state-of-the-art transfer molding.

The construction of the sensing head leads to a very low angular dependence which facilitate the installation. The mounting flange allows for easy adjustment of the immersion depth.

The measuring range and the response time of EE650 can be selected with jumpers on the electronics board, see below "Settings".

EE650 is dedicated for heating, ventilation and air conditioning applications. For special applications do not hesitate to contact the manufacturer or their local distributor.

CAUTION

- Accurate measurement results are conditioned by the correct positioning of the sensing probe in the air stream. Best accuracy is achieved in laminar flow.
- Observe the minimum inlet and outlet path length, see page 4.
- Avoid mechanical stress onto the probe and mainly onto the sensing head.
- Observe the humidity working range 5...95% RH, non-condensing.
- Avoid installation in corrosive environment, as this may lead to sensor destruction.

CONNECTING DIAGRAM

Analogue output

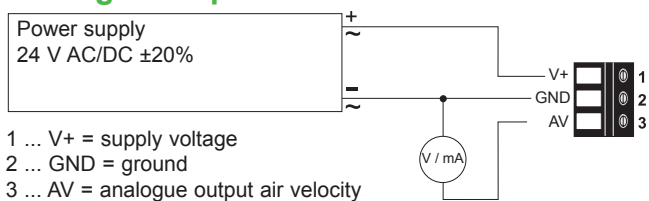

Remote sensor probe

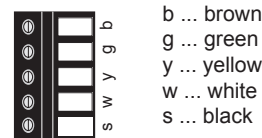

RS485 Interface

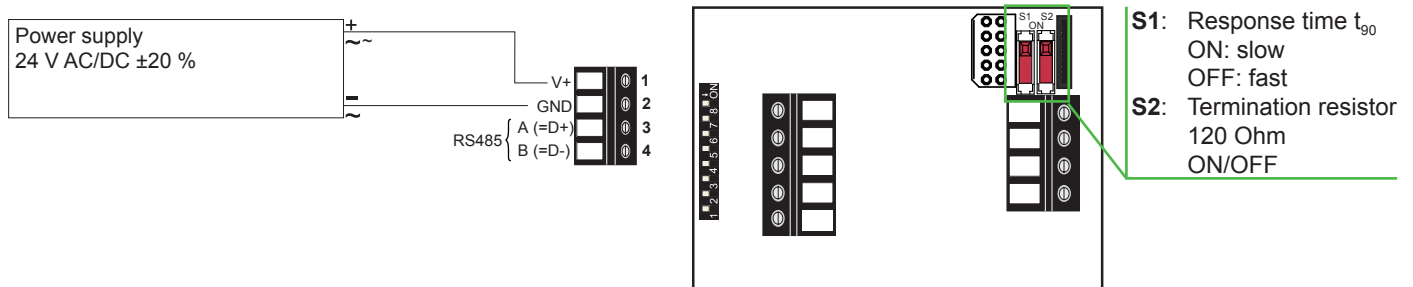

ANALOGUE SETTINGS

For performing EE650 settings via EE-PCS Product Configuration Software (download from www.epluse.com/configurator) the working range jumper must be on HI.

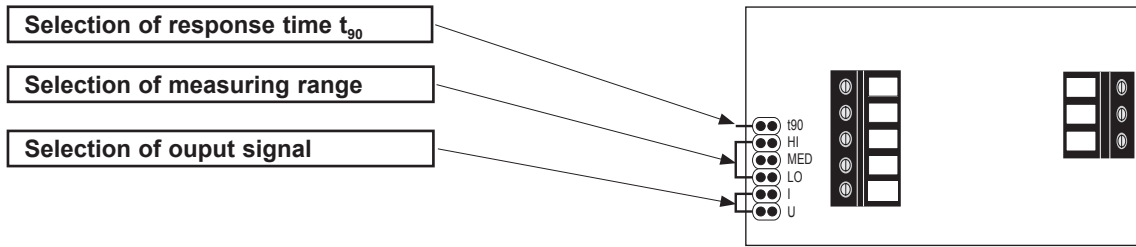

Selection of output signal



Jumper I
CURRENT
(factory setting)



Jumper U
VOLTAGE

Selection of response time t_{90}



Jumper t90
SLOW 4 sec.
(factory setting)



no jumper
FAST 1 sec.

Selection of measuring range



Jumper HI
0...20 m/s (0...4000 ft/min)
(factory setting)



Jumper MED
0...15 m/s (0...3000 ft/min)



Jumper LO
0...10 m/s (0...2000 ft/min)

DIGITAL SETTINGS

Hardware

The bus termination can be realized with the 120 Ohm resistor on board, slide switch S2.

Very important:

For proper function the power supply must be strong enough to ensure supply voltage within the specified range (see technical data) at any time and at all devices in the bus. This is particularly relevant when using long and thin cables which can cause high voltage drop; please note that a single EE650 requires peak current of 150 mA.

Address Setting

Address Switch

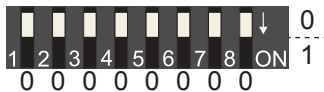

Address setting via EE-PCS Product Configuration Software:

All DIP switches at position 0 → address has to be set via PCS

Modbus (Slave device): factory setting EE650: 65 (permitted values: 1...247).

BACnet (Master device): factory setting EE650: 65 (permitted values: 0...127).

Example: Slave address is set via configuration software.

Address Switch



Address setting via DIP switch:

Modbus (Slave device): Setting the DIP switches to any other address than 0, overrules the slave address set via configuration software (permitted values: 1...247).

BACnet (Master device): Setting the DIP switches to any other address than 0, overrules the slave address set via configuration software.

BACnet Note: permitted values are 0...127.

The 8th bit of the DIP switches is ignored (ID 127 = 0111 111).

To set address 0 via DIP switches, the 8th bit shall be set to 1 (ID 0 = 1000 0000).

Example: Slave address set to 11 (= 0000 1011 binary).

BACnet Setup

Please see PICS (Product Implementation Conformance Statement) - available on www.epluse.com/EE650

Modbus Setup

FLOAT (read register):

Function code / Register number ¹⁾ [Dec]	Register address ²⁾ [HEX]	Parameter name	
31003	0x03EA	Temperature	[°C]
31005	0x03EC	Temperature	[°F]
31041	0x0410	Airflow	[m/s]
31043	0x0412	Airflow	[ft/min]

INFO (read register):

Function code / Register number ¹⁾ [Dec]	Register address ²⁾ [HEX]	Parameter name
30001	0x00	Serial number (as ASCII)
30009	0x08	Firmware version

SHORT (read register)³⁾:

Function code / Register number ¹⁾ [Dec]	Register address ²⁾ [HEX]	Parameter name	
34002	0x0FA1	Temperature*	[°C]
34003	0x0FA2	Temperature**	[°F]
34021	0x0FB4	Airflow*	[m/s]
34022	0x0FB5	Airflow***	[ft/min]

* Values are stored with the scale 1:100 (e.g.: 2550 is equivalent to 25.5 °C)

** Values are stored with the scale 1:50 (e.g.: 2550 is equivalent to 51 °F)

*** Values are stored with the scale 1:1

INTEGER (write register):

Function code / Register number ¹⁾ [Dec]	Register address ²⁾ [HEX]	Parameter name
60001	0x00	Slave-ID* (modbus address)
60002	0x01	Modbus protocol settings ³⁾

* If the ID is set via DIP-Switch the response will be NAK.

1) Register number starts from 1

2) Register number starts from 0

3) For Modbus protocol setting please see Application Note Modbus (www.epluse.com)

MODBUS RTU EXAMPLE

Example of MODBUS RTU command for reading the temperature (float value) T = 26,652524 °C from the register 0x03EA

Device EE650; slave ID 65

Reference document, chapter 6.3: http://www.modbus.org/docs/Modbus_Application_Protocol_V1_1b.pdf

Request [Hex]: 41 03 03 EA 00 02 EB 7B

	Modbus ID address	Function code	Starting address Hi	Starting address Lo	No. of register Hi	No. of register Lo	CRC	
Request [Hex]:	41	03	03	EA	00	02	EB	7B

Response [Hex]: 41 03 04 38 5F 41 D5 0A E3

	Modbus ID address	Function code	Byte count	Register 1 value Hi	Register 1 value Lo	Register 2 value Hi	Register 2 value Lo	CRC	
Response [Hex]:	41	03	04	38	5F	41	D5	0A	E3

Protocol setting:

Address, baudrate, parity and stop bits can be set via:

1. Product Configurator Software (available on www.epluse.com/ee650)
2. Modbus protocol (please see Application Note Modbus (available on www.epluse.com/ee650))

CONFIGURATION AND ADJUSTMENT

The EE650 as ordered is ready for use immediately and requires no configuration by the user. If required, the optional Configuration Adapter Cable and the E+E Product Configuration Software (EE-PCS) can be used for changing the factory setup as well as for adjusting of the air velocity measurement.

Note: The EE650 must not have any additional power supply when using the Configuration Adapter Cable HA011066.

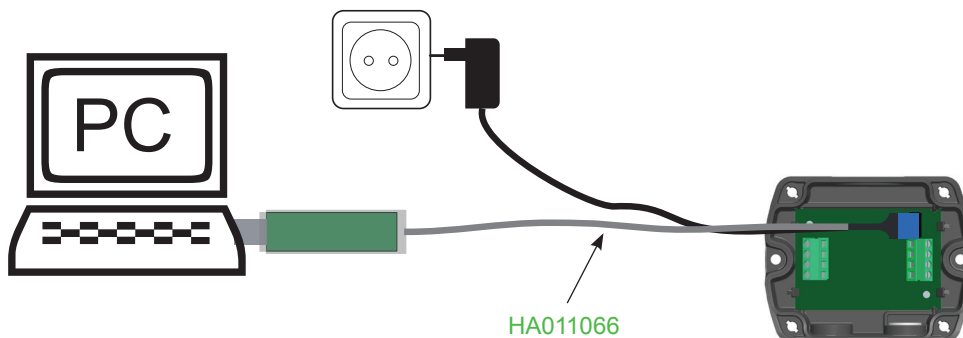

For product data sheets EE-PCS please see www.epluse.com.

The E+E Product Configuration Software (EE-PCS) is free and can be downloaded from www.epluse.com/configurator.

TECHNICAL DATA



Measuring range

Working range ¹⁾	0...10 m/s (0...2000 ft/min)	
	0...15 m/s (0...3000 ft/min)	
	0...20 m/s (0...4000 ft/min) (factory setting)	
Accuracy at 20 °C ²⁾ (68 °F), 45 % RH, 1013 hPa	0.2...10 m/s (40...2000 ft/min)	± (0.2 m/s (40 ft/min) + 3 % of m. v.)
	0.2...15 m/s (40...3000 ft/min)	± (0.2 m/s (40 ft/min) + 3 % of m. v.)
	0.2...20 m/s (40...4000 ft/min)	± (0.2 m/s (40 ft/min) + 3 % of m. v.)
Response time τ_{90} ¹⁾	typ. 4 sec. (factory setting) or	typ. 1 sec. at constant temperature

Output

Analogue ¹⁾ 0...10 m/s / 0...15 m/s / 0...20 m/s	0 - 10 V	-1 mA < I_L < 1 mA
	4 - 20 mA (factory setting)	$R_L < 500 \Omega$ (linear, 3-wires)
Digital interface Protocol	RS485 with max. 32 devices on one bus Modbus RTU or BACnet MS/TP	

General

Power supply (Class III) 	24 V AC/DC ± 20 %	
Current consumption		AC supply
	Analogue output	max. 170 mA
	DC supply	max. 70 mA
	RS485	max. 50 mA
Electrical connection	screw terminals max. 1.5 mm ² (AWG 16)	
Cable gland	M16x1.5	
Electromagnetic compatibility	EN61326-1	EN61326-2-3
	Industrial Environment 	
Enclosure material	Polycarbonate, UL94V-0 approved	
Protection class	Enclosure IP65 / NEMA 4, remote probe IP20	
Temperature range	working temperature probe	-25 ... 50 °C (-13...122 °F)
	working temperature electronic	-10 ... 50 °C (14...122 °F)
	storage temperature	-30 ... 60 °C (-22...140 °F)
Working range humidity	5...95 % RH (non-condensing)	

1) Selectable by jumper, only for analogue output

2) The accuracy statement includes the uncertainty of the factory calibration with an enhancement factor k=2 (2-times standard deviation).

The accuracy was calculated in accordance with EA-4/02 and with regard to GUM (Guide to the Expression of Uncertainty in Measurement).

DIMENSIONS MM (INCH)

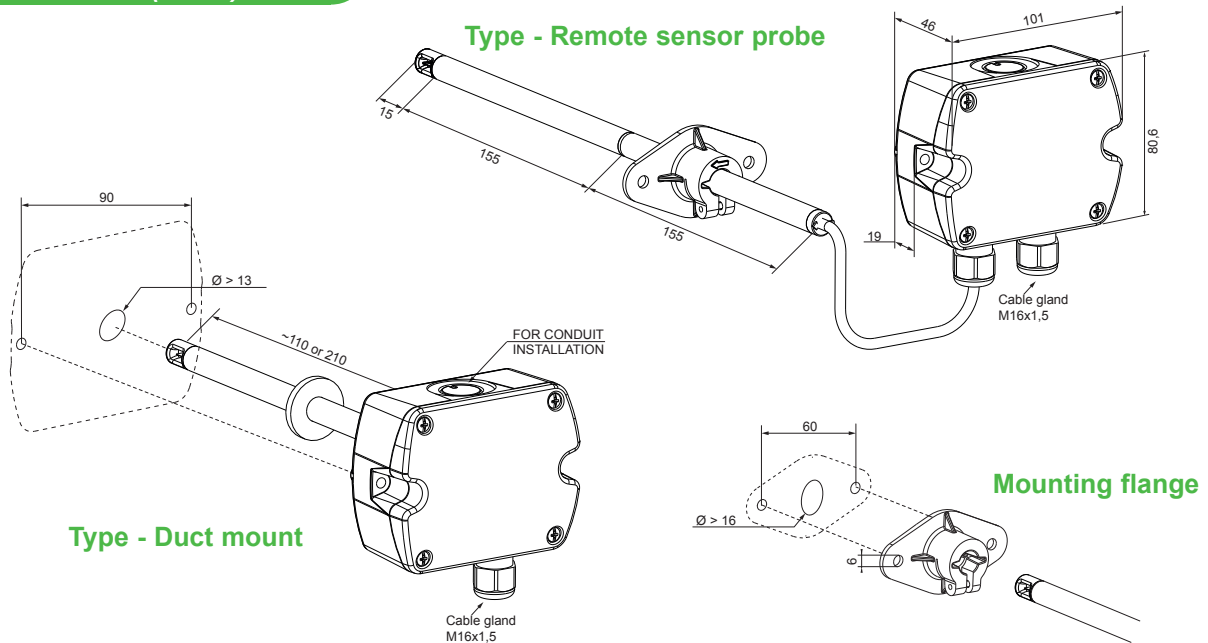

SCOPE OF SUPPLY

- EE650 Transmitter according to ordering guide
- Cable gland (two pieces at output RS485 for daisy chain wiring)
- Mounting flange
- Mounting materials
- Protection cap
- Quick guide
- Two self-adhesive labels for configuration changes (see user guide at www.epluse.com/relabeling)
- Test report according to DIN EN10204 - 2.2

ACCESSORIES

- USB configuration adapter
- Product configuration software
- Power supply adapter

HA011066

EE-PCS (free download: www.epluse.com/EE650)

V03 (see data sheet Accessories)

MOUNTING

DRILLING IN THE WALL OF THE DUCT FOR INSTALLING THE MOUNTING FLANGE

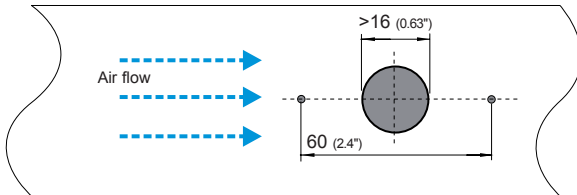

The arrow engraved on the sensing head of EE650 indicates the direction of the air stream during factory adjustment. When installing the EE650 probe, make sure that the arrow matches exactly the flow direction.

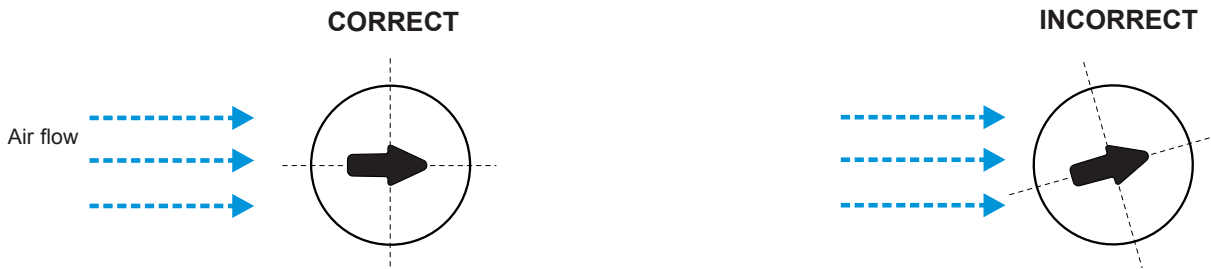

The mounting flange allows for precise setting of the EE650 immersion depth in a duct. The entire sensing head must be in the air flow to be measured.

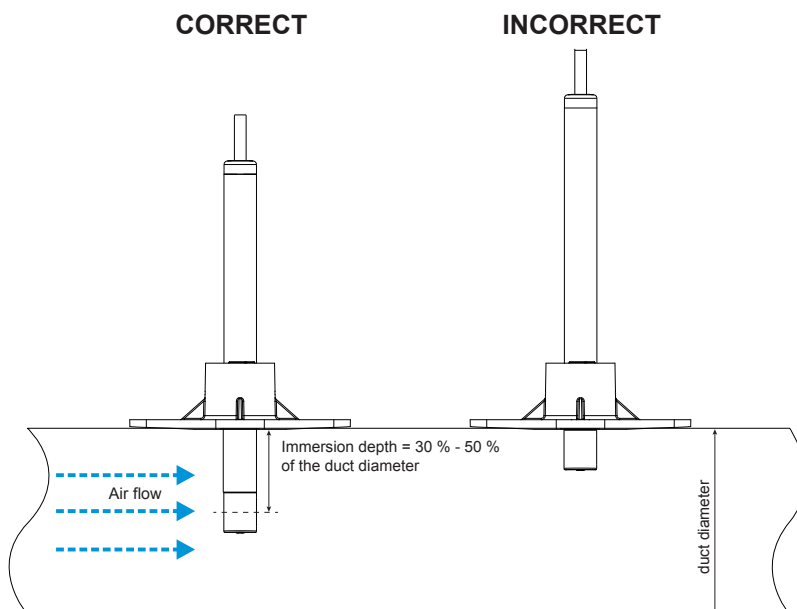

POSITIONING OF AIR VELOCITY SENSOR IN A VENTILATION DUCT

The reliable and accurate measurement of air velocity depends on the correct positioning of the sensor in the ventilation duct. Accurate measurements are only possible if the air velocity probe is positioned at a location with a laminar (not-turbulent) flow.

The required length of the calming section after a fault is a function of the tube diameter D. For a rectangular channel a x b applies:

$$D_{gl} = \frac{2 \cdot a \cdot b}{a + b}$$

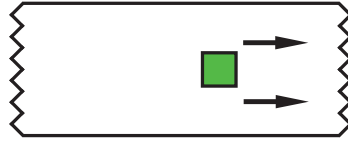

Mounting the sensing probe in the middle of the channel.

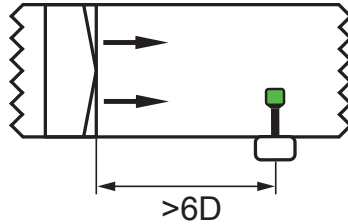
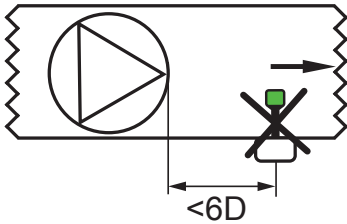

The optimal position is after the filter. Please note sufficient distance.

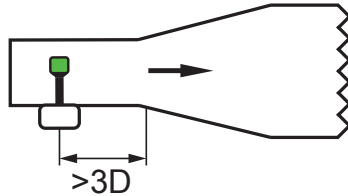
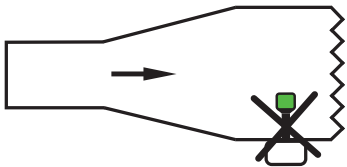

Positioning the probe ahead of diffuser, at a place with high flow rate.

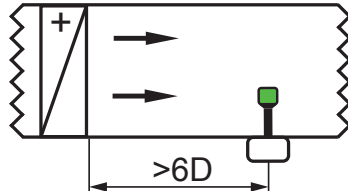
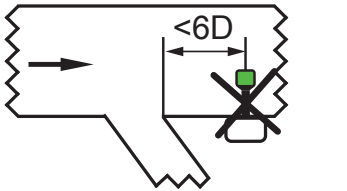

Positioning the probe at a location with a laminar (to-turbulent) flow.

Turbulent flows are caused by pipe bends, branches, behind flaps, flaps, air heaters, air coolers or cross-sectional changes.

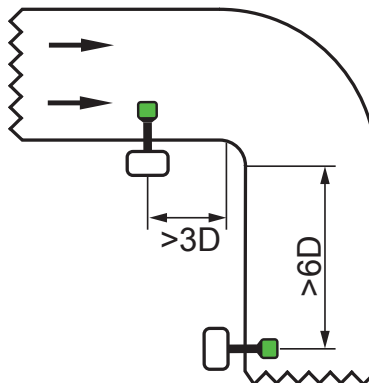
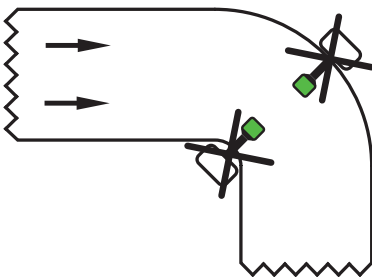

MAINTENANCE OF THE E+E AIR VELOCITY TRANSMITTERS

Due to the absence of moving parts, the E+E air velocity transmitters are not subject to wear. The construction (shape, dimensions and materials) of the hot film air velocity sensor is per se highly insensitive to dust and dirt. No maintenance is required under normal environmental conditions. For operation in polluted environment it is advisable to periodically clean the sensing head by washing it in isopropyl alcohol, preferably in an ultrasound cleaner. Alternatively shake it gently few minutes in a pot with isopropyl alcohol and let it dry free. Do not touch or rub the sensor and do not use any mechanical tools for cleaning.

E+E Elektronik Ges.m.b.H. doesn't accept warranty and liability claims neither upon this publication nor in case of improper treatment of the described products.

The document may contain technical inaccuracies and typographical errors. The content will be revised on a regular basis. These changes will be implemented in later versions. The described products can be improved and changed at any time without prior notice.

© Copyright E+E Elektronik Ges.m.b.H.
All rights reserved.

EMC note USA (FCC):

This equipment has been tested and found to comply with the limits for a Class A digital device, pursuant to part 15 of the FCC Rules. These limits are designed to provide reasonable protection against harmful interference when the equipment is operated in a commercial environment. This equipment generates, uses, and can radiate radio frequency energy and, if not installed and used in accordance with the instruction manual, may cause harmful interference to radio communications. Operation of this equipment in a residential area is likely to cause harmful interference in which case the user will be required to correct the interference at his own expense.

EMC note Canada (ICES-003):

CAN ICES-3 (A) / NMB-3 (A)

INFORMATION

+43 7235 605 0 / info@epluse.com

E+E Elektronik Ges.m.b.H.
Langwiesen 7 • A-4209 Engerwitzdorf
Tel: +43 7235 605-0 • Fax: +43 7235 605-8
info@epluse.com • www.epluse.com
LG Linz Fn 165761 t • UID-Nr. ATU44043101
Place of Jurisdiction: A-4020 Linz • DVR0962759

